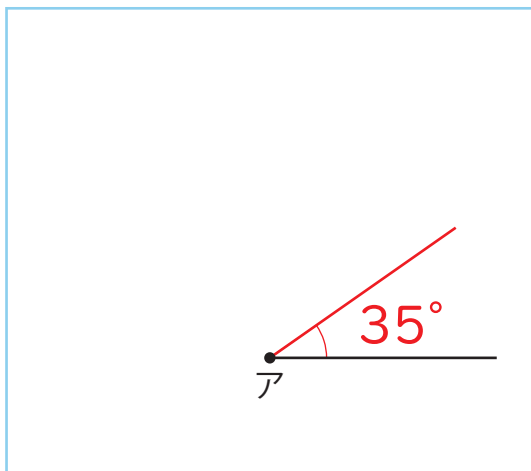
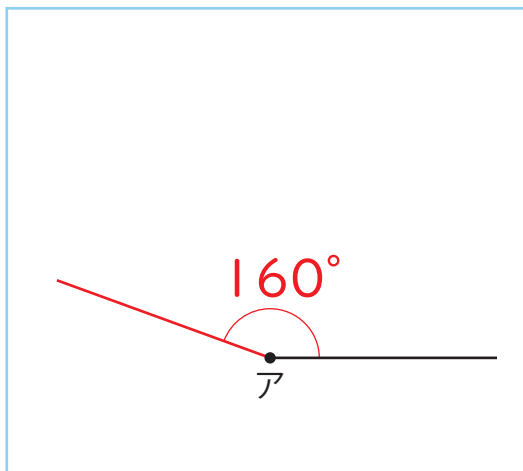
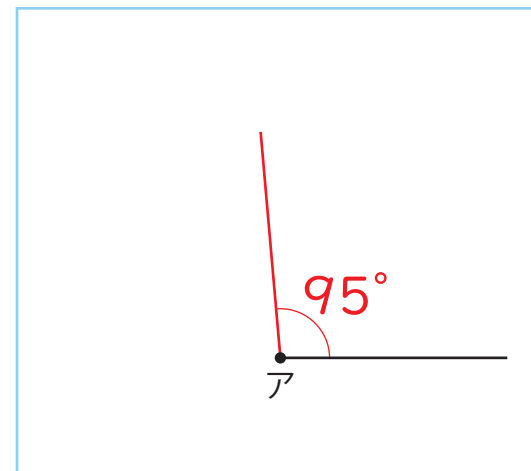
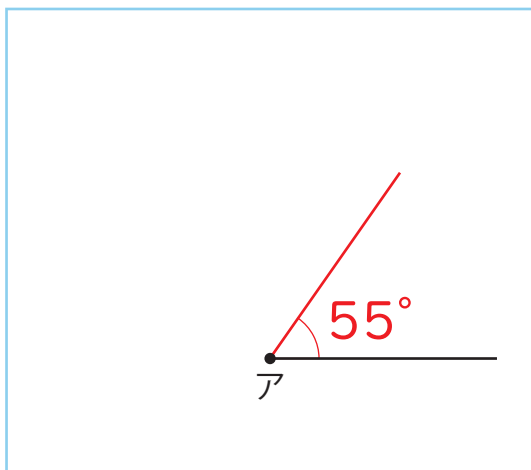
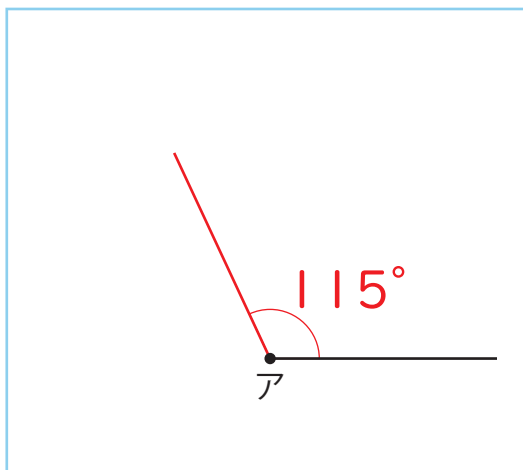

- ^{ぶんどき}分度器の中心を点アに合わせて次の角度をかきましょう。

1 35° 2 160° 3 95° 4 55° 5 115° 6 180° 