

- ^{ぶんどき}分度器の中心を点アに合わせて次の角度をかきましょう。

1 150°

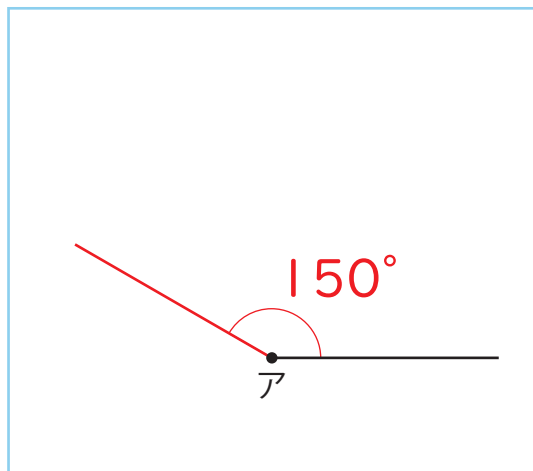

2 95°

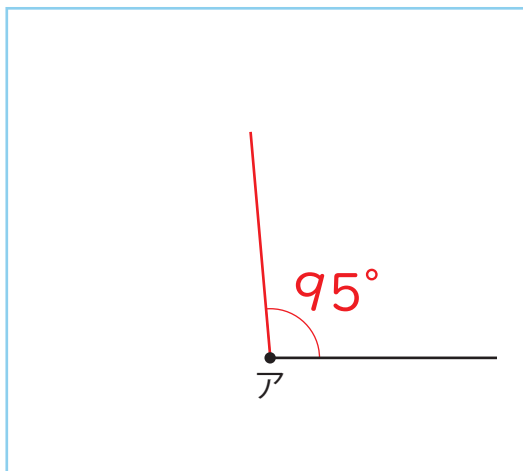

3 145°

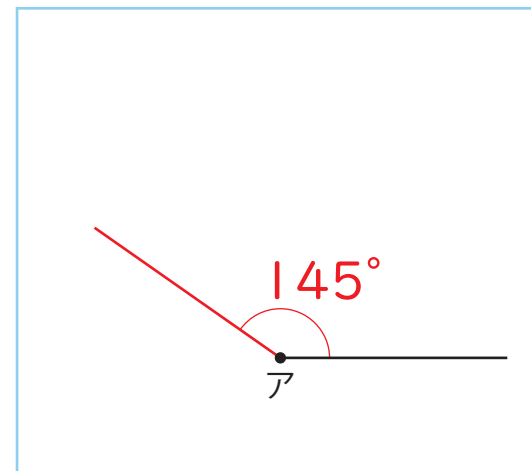

4 175°

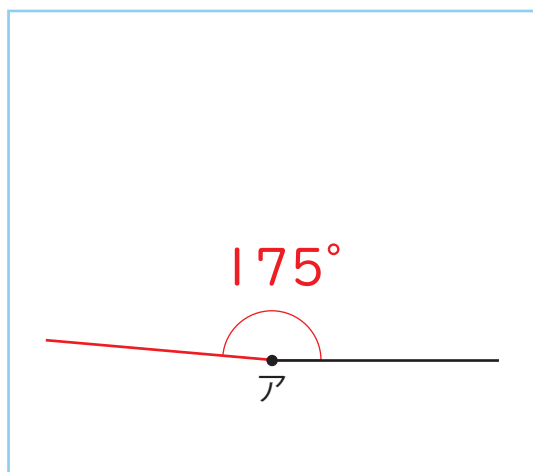

5 115°

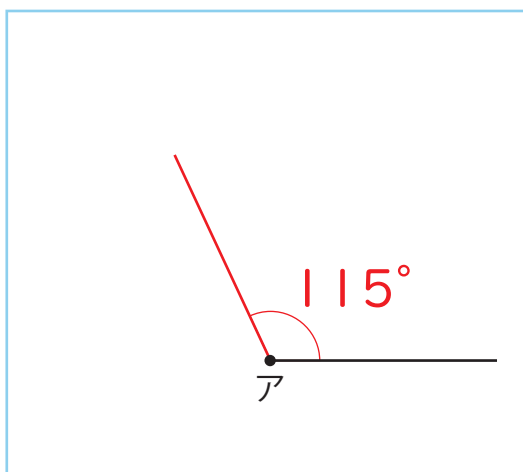

6 100°

