

- ^{ぶんどき}分度器の中心を点アに合わせて次の角度をかきましょう。

1 140°

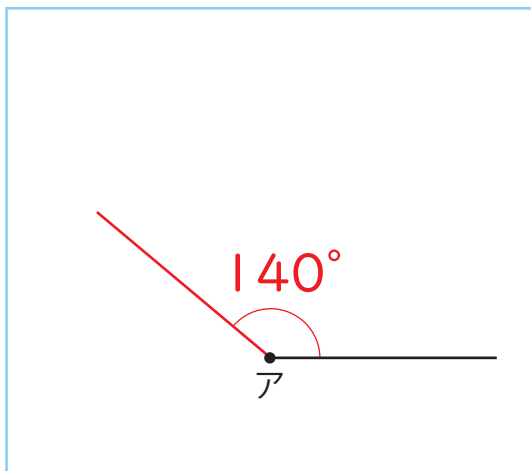

2 100°

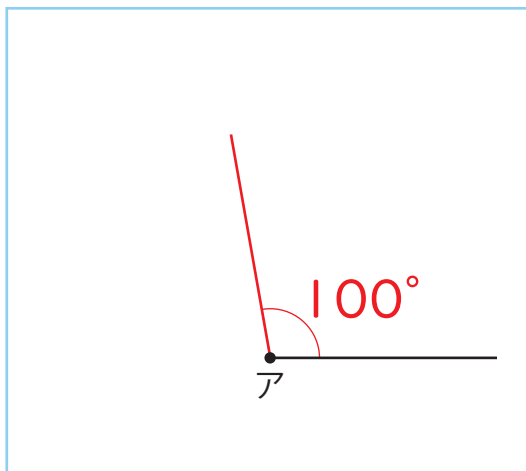

3 110°

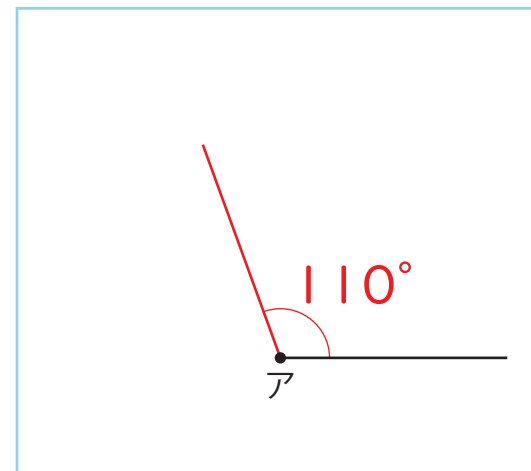

4 150°

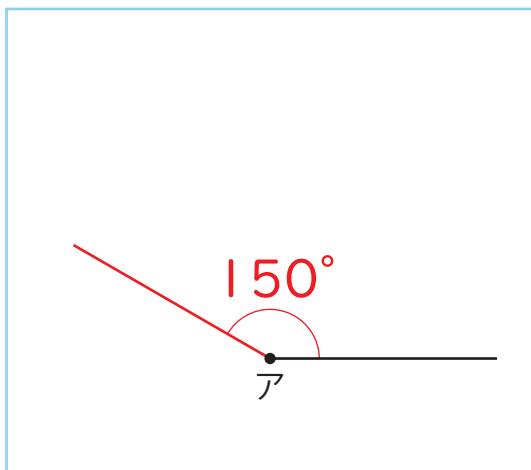

5 130°

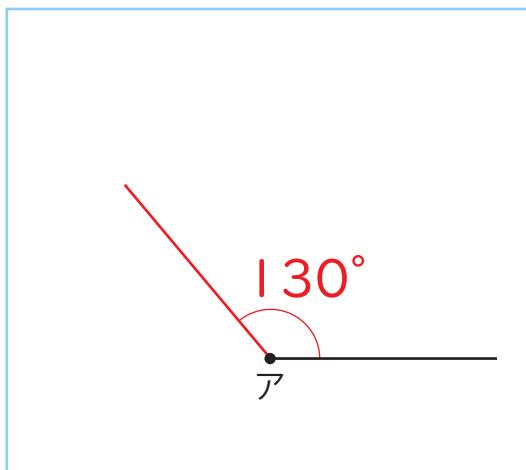

6 160°

