

- <sup>ぶんどき</sup>分度器の中心を点アに合わせて次の角度をかきましょう。

1 150°

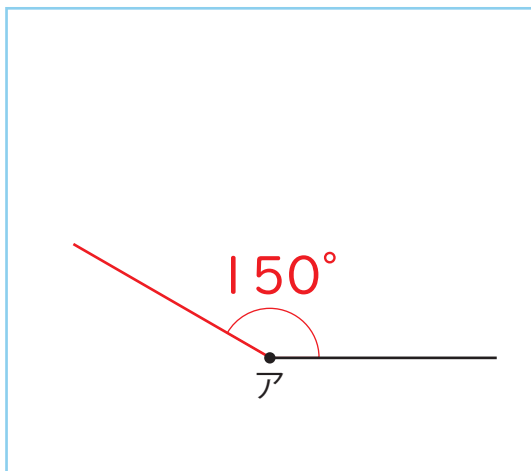

2 130°

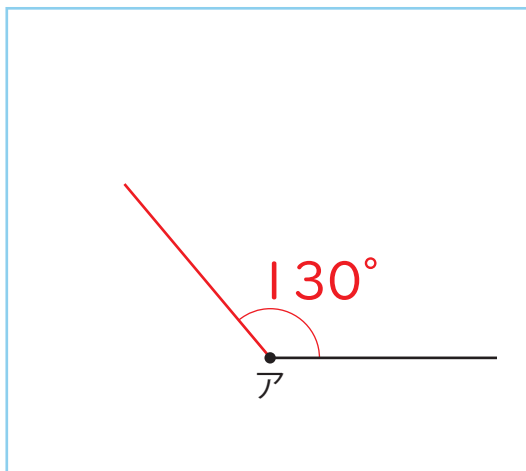

3 170°

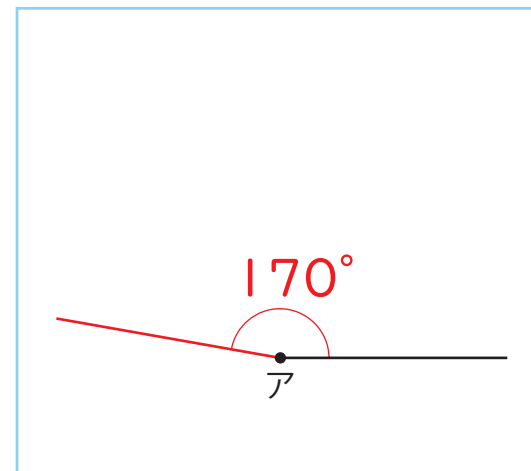

4 160°

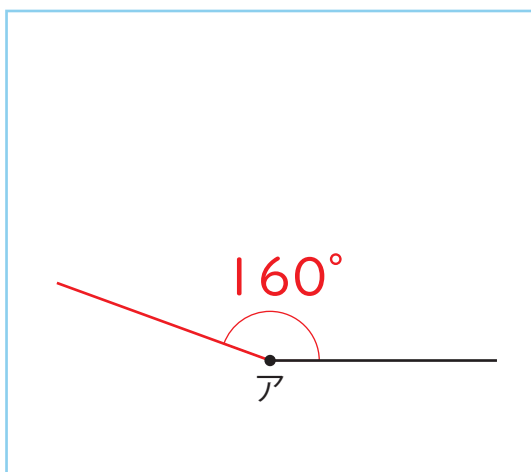

5 110°

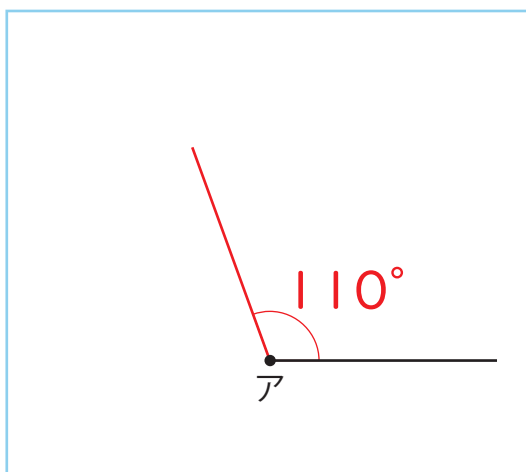

6 120°

