

- <sup>ぶんどき</sup>分度器の中心を点アに合わせて次の角度をかきましょう。

1 185°

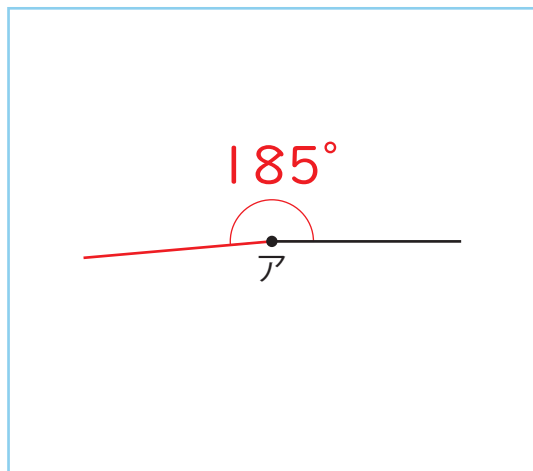

2 240°

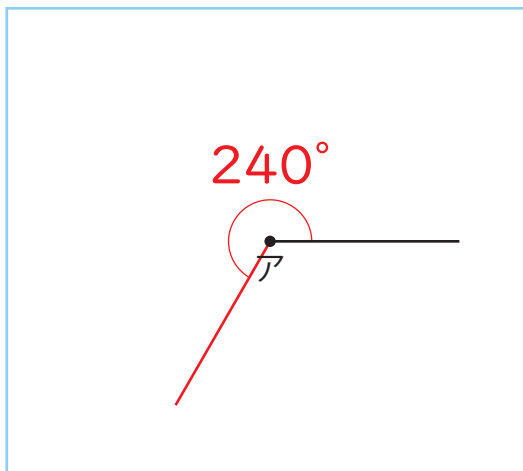

3 315°

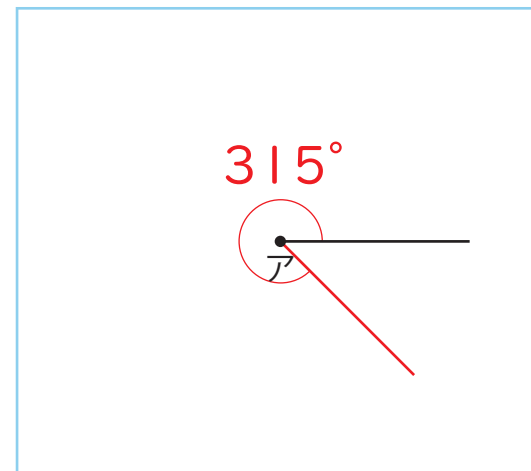

4 285°

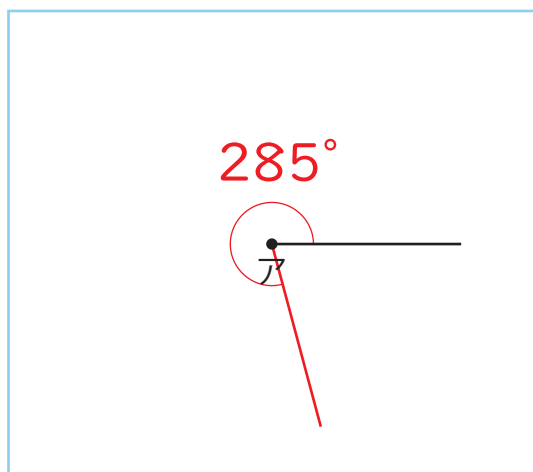

5 215°

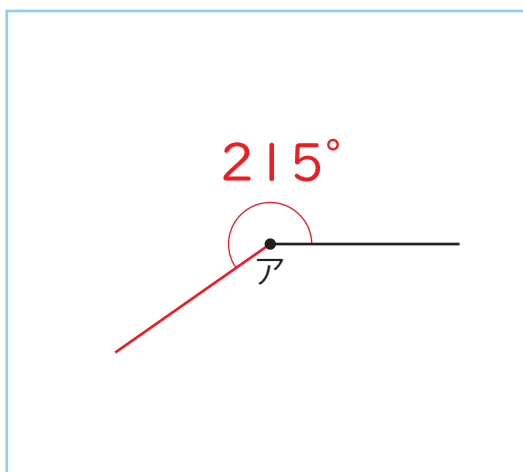

6 340°

