

- ^{ぶんどき}分度器の中心を点アに合わせて次の角度をかきましょう。

1 275°

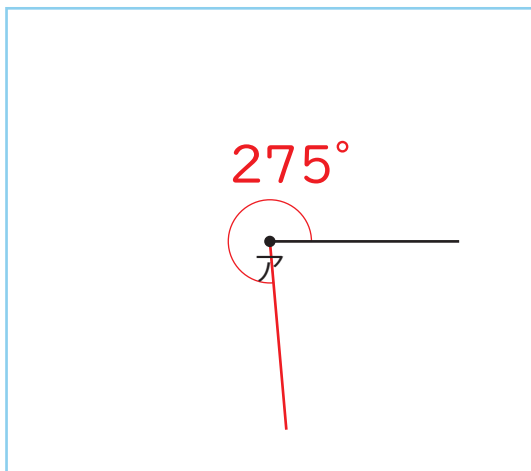

2 200°

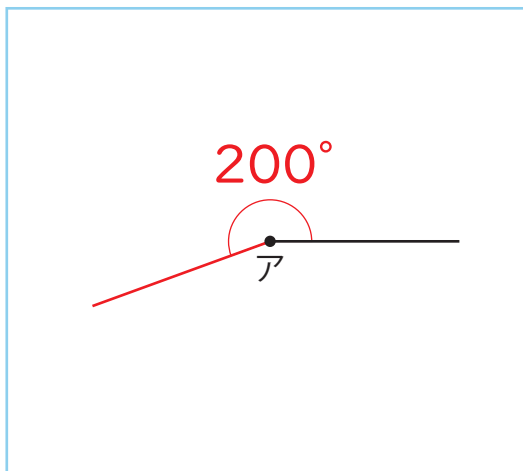

3 205°

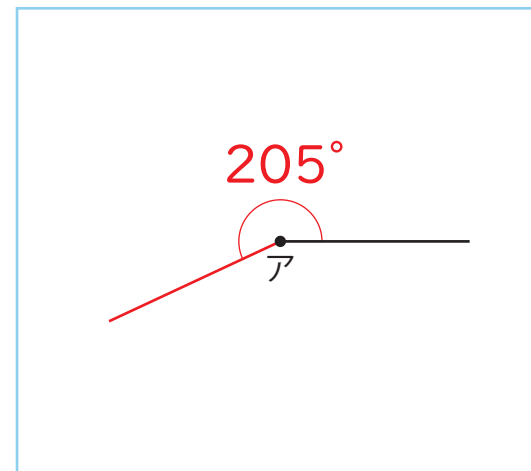

4 335°

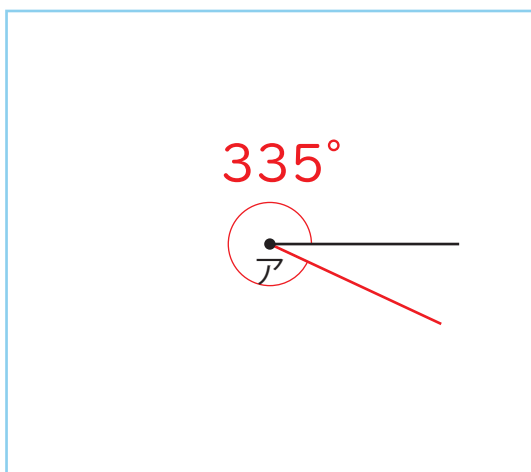

5 245°

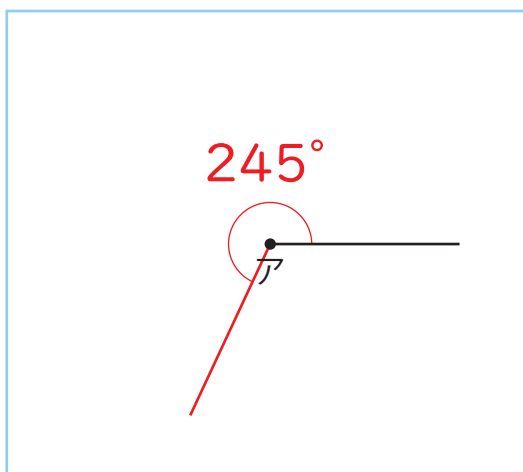

6 290°

