

- ^{ぶんどき}分度器の中心を点アに合わせて次の角度をかきましょう。

1 210°

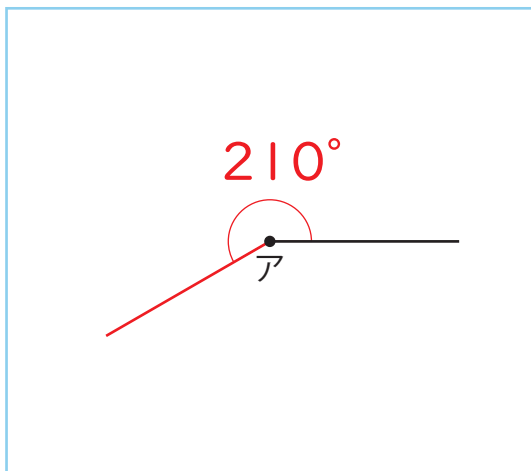

2 330°

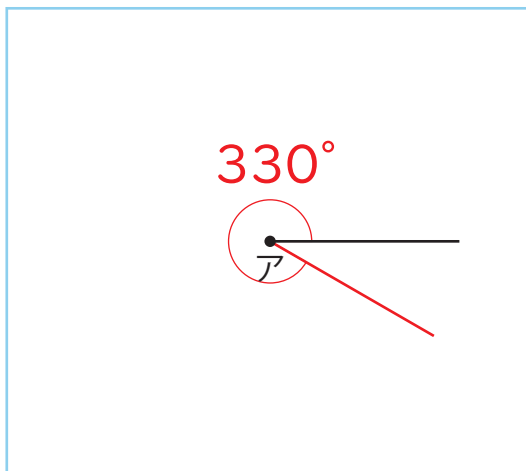

3 300°

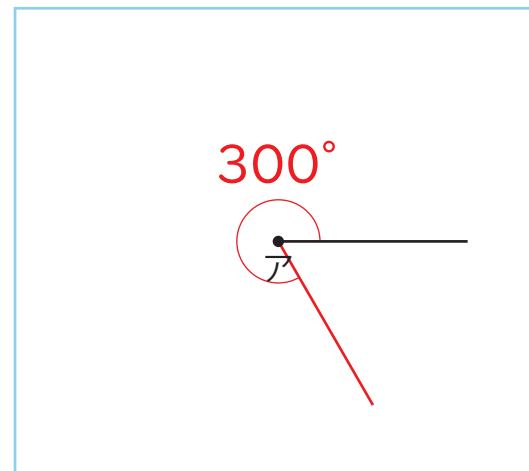

4 270°

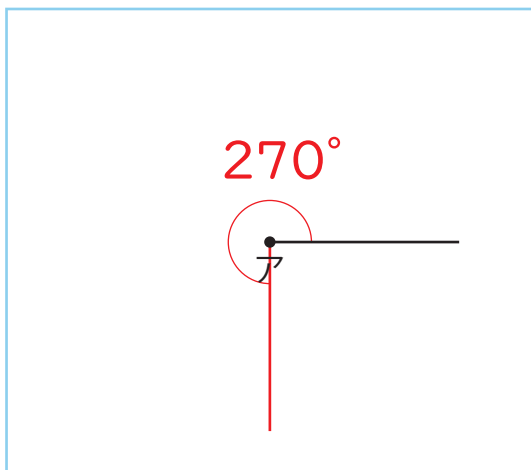

5 250°

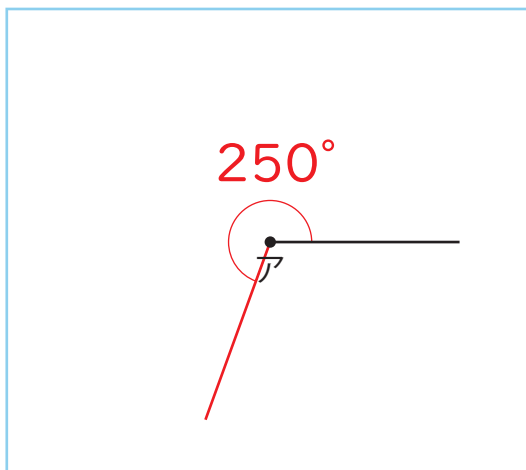

6 350°

